

HEXFET® Power MOSFET

V_{DS}	-20	V
$R_{DS(on) max}$ (@ $V_{GS} = -4.5V$)	135	mΩ
Q_g (typical)	2.9	nC
I_D (@ $T_A = 25^\circ C$)	-2.6	A

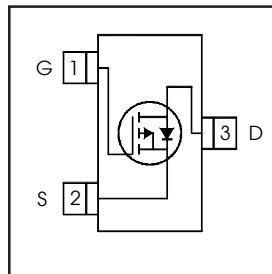

Features

Industry-standard pinout SOT-23 Package
Compatible with Existing Surface Mount Techniques
RoHS Compliant, Halogen-Free
MSL1, Industrial qualification



Benefits

Multi-Vendor Compatibility
Easier Manufacturing
Environmentally Friendlier
Increased Reliability

Base Part Number	Package Type	Standard Pack		Orderable Part Number
		Form	Quantity	
IRLML2246TRPbF-1	Micro3™ (SOT-23)	Tape and Reel	3000	IRLML2246TRPbF-1

Absolute Maximum Ratings

Symbol	Parameter	Max.	Units
V_{DS}	Drain-Source Voltage	-20	V
$I_D @ T_A = 25^\circ C$	Continuous Drain Current, $V_{GS} @ -10V$	-2.6	A
$I_D @ T_A = 70^\circ C$	Continuous Drain Current, $V_{GS} @ -10V$	-2.1	
I_{DM}	Pulsed Drain Current	-11	
$P_D @ T_A = 25^\circ C$	Maximum Power Dissipation	1.3	W
$P_D @ T_A = 70^\circ C$	Maximum Power Dissipation	0.80	
	Linear Derating Factor	0.01	
V_{GS}	Gate-to-Source Voltage	± 12	V
T_J, T_{STG}	Junction and Storage Temperature Range	-55 to + 150	$^\circ C$

Thermal Resistance

Symbol	Parameter	Typ.	Max.	Units
$R_{\theta JA}$	Junction-to-Ambient ③	—	100	$^\circ C/W$
$R_{\theta JA}$	Junction-to-Ambient ($t < 10s$) ④	—	99	

Electric Characteristics @ T_J = 25°C (unless otherwise specified)

Symbol	Parameter	Min.	Typ.	Max.	Units	Conditions
V _{(BR)DSS}	Drain-to-Source Breakdown Voltage	-20	—	—	V	V _{GS} = 0V, I _D = -250μA
ΔV _{(BR)DSS} /ΔT _J	Breakdown Voltage Temp. Coefficient	—	9.5	—	mV/°C	Reference to 25°C, I _D = -1mA
R _{DS(on)}	Static Drain-to-Source On-Resistance	—	90	135	mΩ	V _{GS} = -4.5V, I _D = -2.6A ②
		—	157	236		V _{GS} = -2.5V, I _D = -2.1A ②
V _{GS(th)}	Gate Threshold Voltage	-0.4	—	-1.1	V	V _{DS} = V _{GS} , I _D = -10μA
I _{DSS}	Drain-to-Source Leakage Current	—	—	-1.0	μA	V _{DS} = -16V, V _{GS} = 0V
		—	—	-150		V _{DS} = -16V, V _{GS} = 0V, T _J = 125°C
I _{GSS}	Gate-to-Source Forward Leakage	—	—	100	nA	V _{GS} = 12V
	Gate-to-Source Reverse Leakage	—	—	-100		V _{GS} = -12V
R _G	Internal Gate Resistance	—	16	—	Ω	
g _{fs}	Forward Transconductance	3.4	—	—	S	V _{DS} = -10V, I _D = -2.6A
Q _g	Total Gate Charge	—	2.9	—	nC	I _D = -2.6A
Q _{gs}	Gate-to-Source Charge	—	0.52	—		V _{DS} = -10V
Q _{gd}	Gate-to-Drain ("Miller") Charge	—	1.2	—		V _{GS} = -4.5V ②
t _{d(on)}	Turn-On Delay Time	—	5.3	—	ns	V _{DD} = -10V ②
t _r	Rise Time	—	7.7	—		I _D = -1.0A
t _{d(off)}	Turn-Off Delay Time	—	26	—		R _G = 6.8Ω
t _f	Fall Time	—	16	—		V _{GS} = -4.5V
C _{iss}	Input Capacitance	—	220	—	pF	V _{GS} = 0V
C _{oss}	Output Capacitance	—	70	—		V _{DS} = -16V
C _{rss}	Reverse Transfer Capacitance	—	48	—		f = 1.0KHz

Source - Drain Ratings and Characteristics

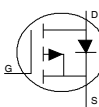
Symbol	Parameter	Min.	Typ.	Max.	Units	Conditions
I _S	Continuous Source Current (Body Diode)	—	—	-1.3	A	MOSFET symbol showing the integral reverse p-n junction diode. 
I _{SM}	Pulsed Source Current (Body Diode) ①	—	—	-11		
V _{SD}	Diode Forward Voltage	—	—	-1.2	V	T _J = 25°C, I _S = -2.6A, V _{GS} = 0V ②
t _{rr}	Reverse Recovery Time	—	17	26	ns	T _J = 25°C, V _R = -15V, I _F = -2.6A
Q _{rr}	Reverse Recovery Charge	—	6.2	9.3	nC	di/dt = 100A/μs ②

Notes:

- ① Repetitive rating; pulse width limited by max. junction temperature.
- ② Pulse width ≤ 400μs; duty cycle ≤ 2%.
- ③ Surface mounted on 1 in square Cu board.
- ④ Refer to [application note #AN-994](#).

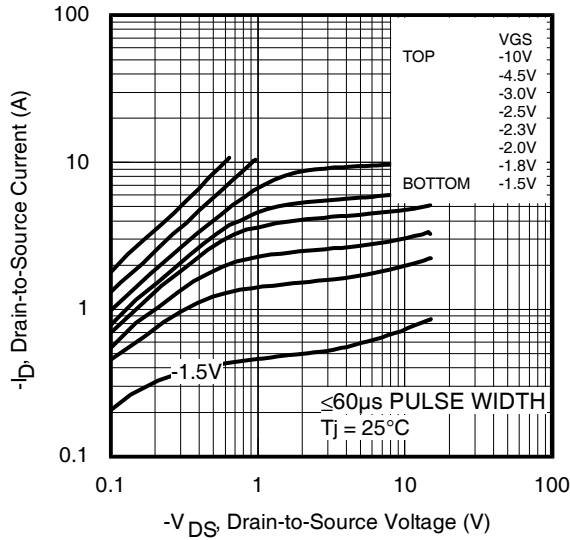
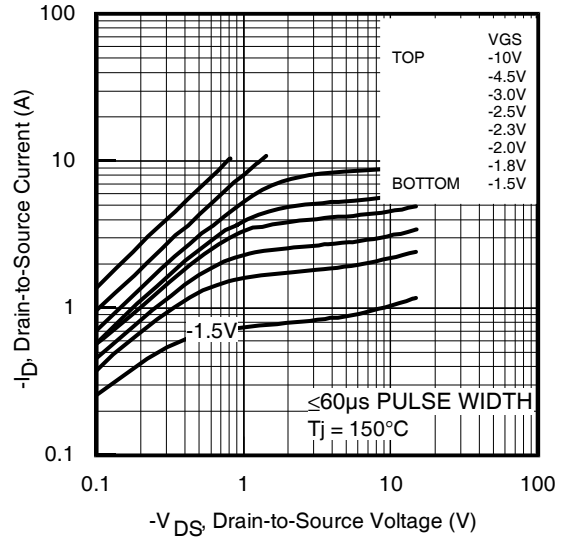
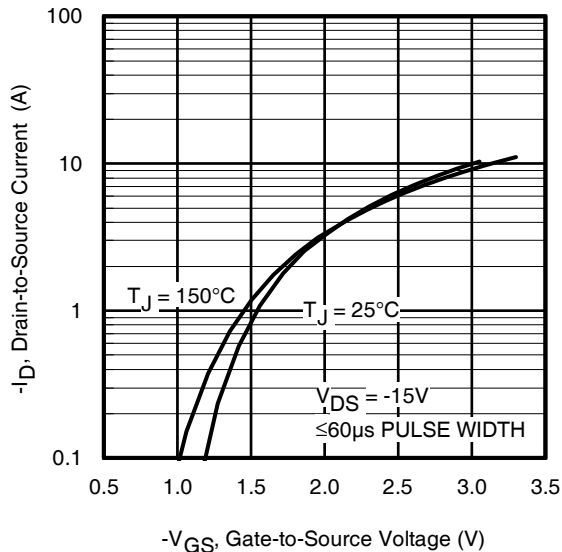
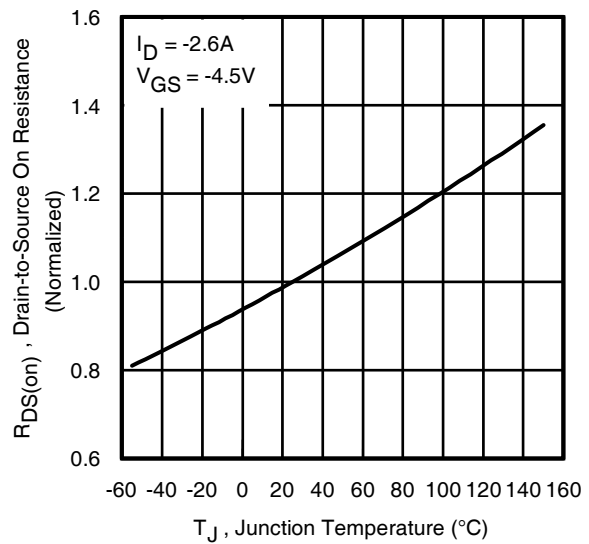
Fig 1. Typical Output Characteristics

Fig 2. Typical Output Characteristics

Fig 3. Typical Transfer Characteristics

Fig 4. Normalized On-Resistance vs. Temperature

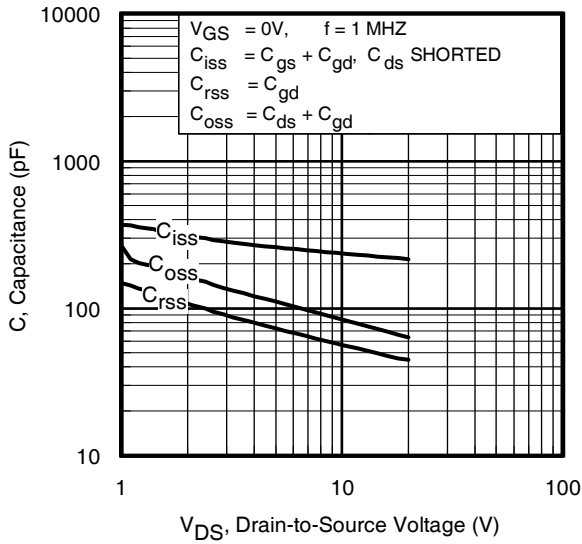

Fig 5. Typical Capacitance vs. Drain-to-Source Voltage

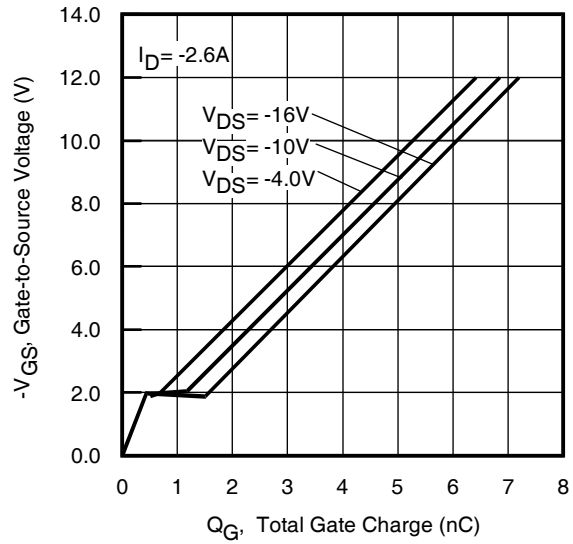

Fig 6. Typical Gate Charge vs. Gate-to-Source Voltage

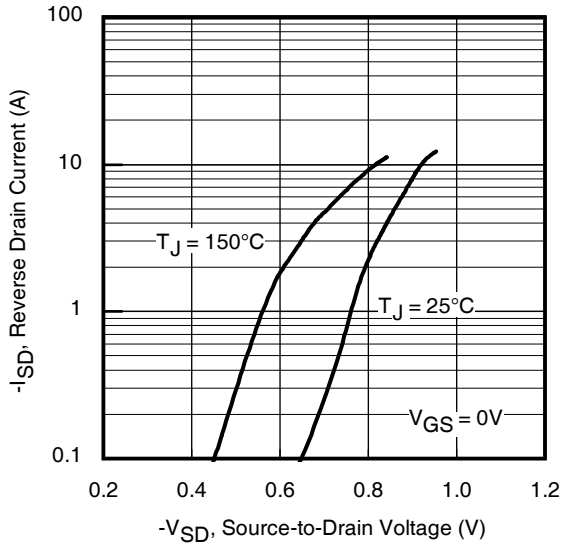

Fig 7. Typical Source-Drain Diode Forward Voltage

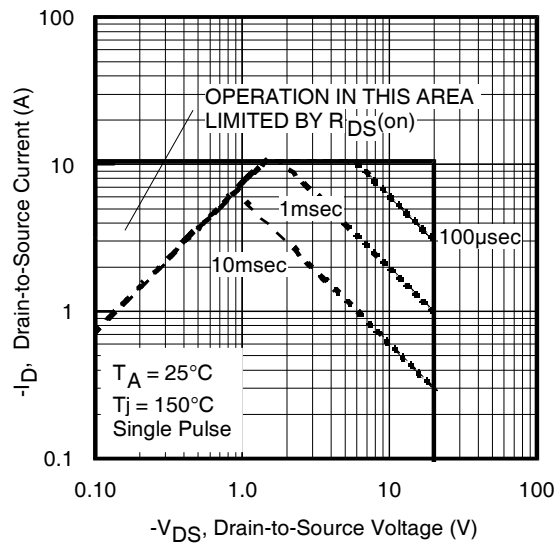

Fig 8. Maximum Safe Operating Area

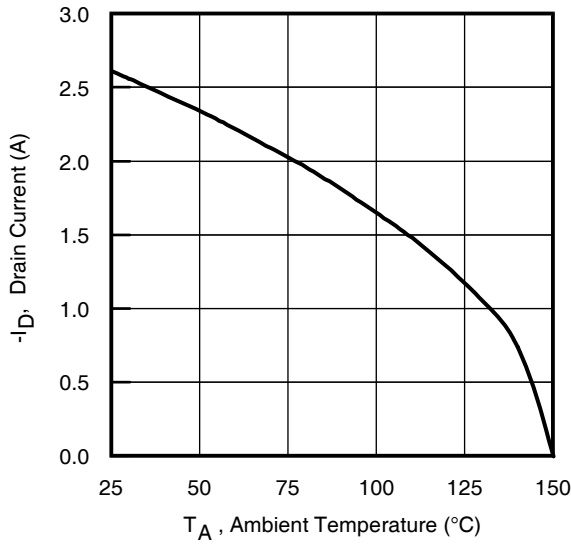

Fig 9. Maximum Drain Current vs. Ambient Temperature

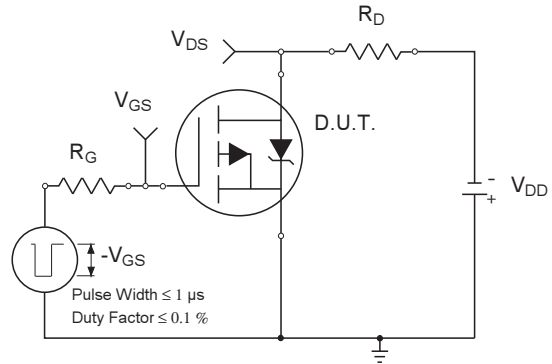

Fig 10a. Switching Time Test Circuit

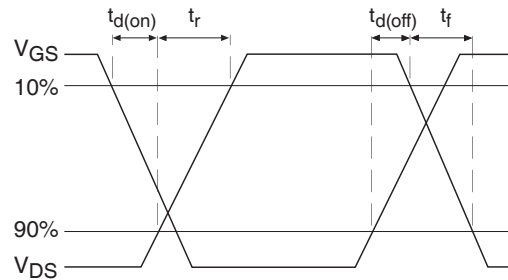

Fig 10b. Switching Time Waveforms

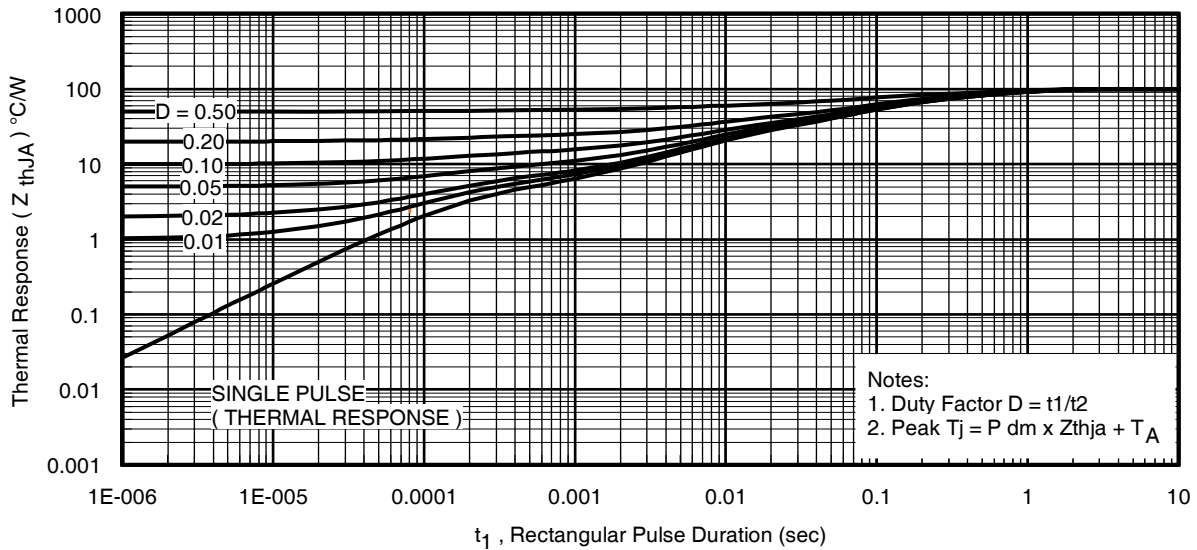
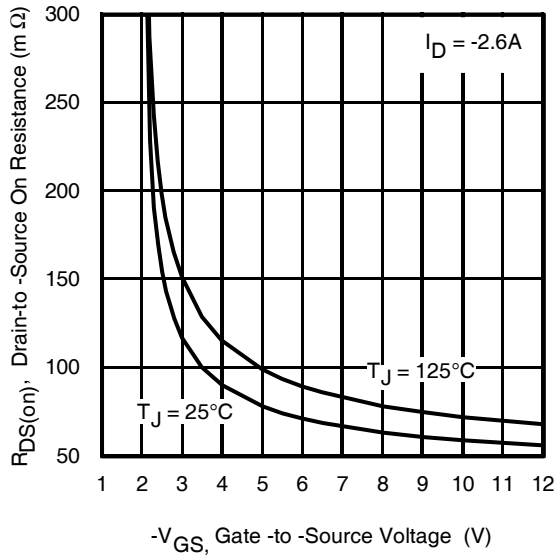
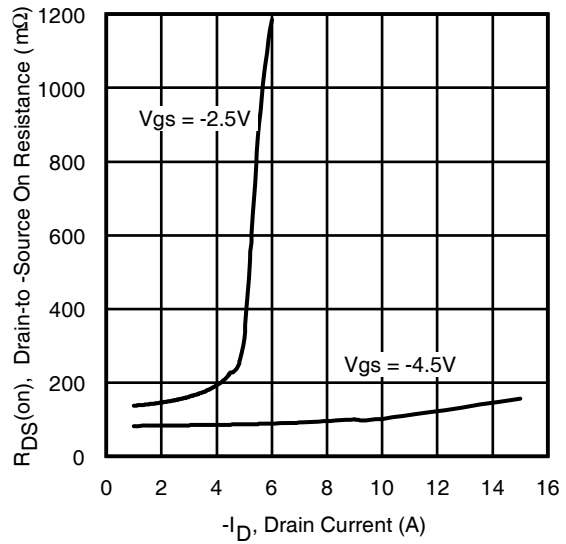
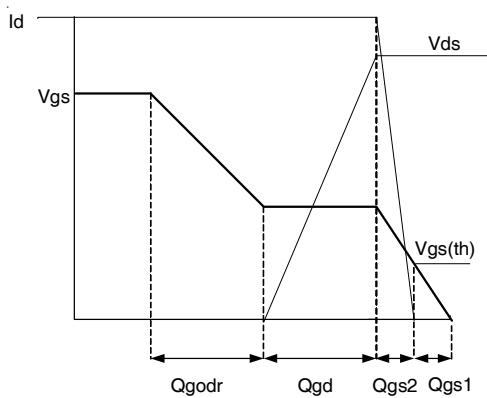
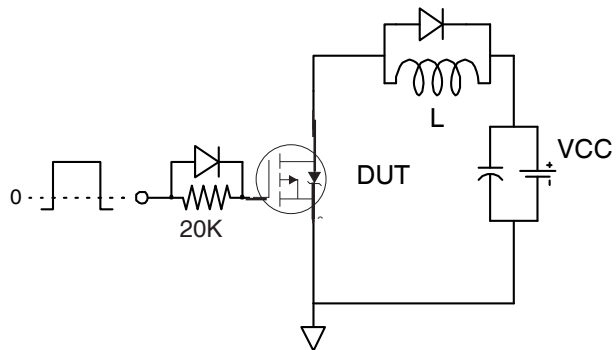

Fig 11. Typical Effective Transient Thermal Impedance, Junction-to-Ambient

Fig 12. Typical On-Resistance vs. Gate Voltage

Fig 13. Typical On-Resistance vs. Drain Current

Fig 14a. Basic Gate Charge Waveform

Fig 14b. Gate Charge Test Circuit

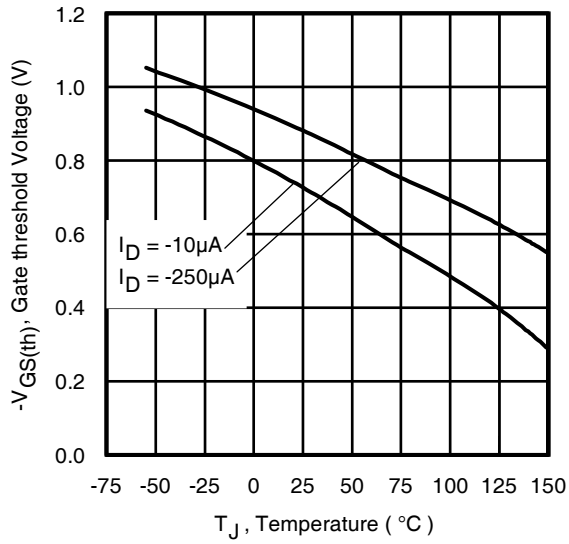

Fig 15. Typical Threshold Voltage vs. Junction Temperature

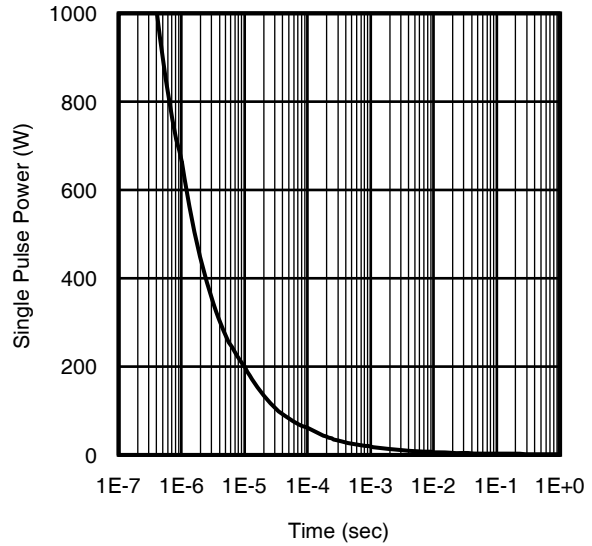

Fig 16. Typical Power vs. Time



IRLML2246PbF-1

Micro3 (SOT-23) (Lead-Free) Package Outline

Dimensions are shown in millimeters (inches)

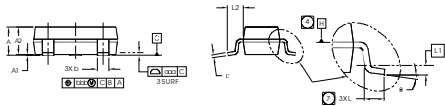
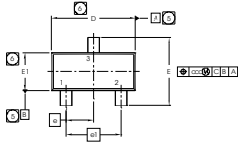

RECOMMENDED FOOTPRINT

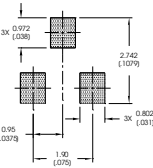

LEAD ASSIGNMENT

1. GATE
2. SOURCE
3. DRAIN

NOTES

1. DIMENSIONING AND TOLERANCING PER ASME Y14.5M-1994.
2. DIMENSIONS ARE SHOWN IN MILLIMETERS (INCHES)
3. CONTROLLING DIMENSION: MILLIMETER.
4. DATUM PLANE H IS LOCATED AT THE MOLD PARTING LINE.
5. DATUM A AND B TO BE DETERMINED AT DATUM PLANE H.
6. DIMENSIONS D AND E1 ARE MEASURED AT DATUM PLANE H. DIMENSIONS DOES NOT INCLUDE MOLD PROTRUSIONS OR INTERLEAD FLASH. MOLD PROTRUSION OR INTERLEAD FLASH SHALL NOT EXCEED 0.25 MM (0.010 INCH) PER SIDE.
7. DIMENSION L IS THE LEAD LENGTH FOR SOLDERING TO A SUBSTRATE.
8. OUTLINE CONFORMS TO JEDEC OUTLINE TO-236AB.

SYMBOL	DIMENSIONS			
	MILLIMETERS		INCHES	
	MIN	MAX	MIN	MAX
A	0.89	1.12	.036	.044
A1	0.01	0.10	.0004	.0039
A2	0.88	1.02	.035	.040
b	0.30	0.50	.0119	.0196
c	0.08	0.20	.0032	.0078
D	2.80	3.04	.111	.119
E	2.10	2.64	.083	.103
E1	1.20	1.40	.048	.055
e	0.95 BSC		.0375 BSC	
e1	1.90 BSC		.075 BSC	
L	0.40	0.60	.0158	.0236
L1	0.25 BSC		.0118 BSC	
L2	0.54 REF		.021 REF	
θ	0°	8°	0°	8°
aaa	0.10		.004	
bbb	0.20		.008	
ccc	0.15		.006	

Micro3 (SOT-23 / TO-236AB) Part Marking Information

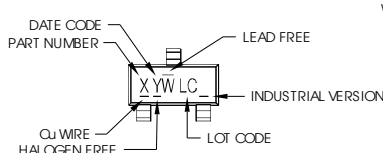

X = PART NUMBER CODE REFERENCE:

- | | |
|---------------|---------------|
| A = IRLML2402 | S = IRLML6244 |
| B = IRLML2803 | T = IRLML6246 |
| C = IRLML6302 | U = IRLML6344 |
| D = IRLML5103 | V = IRLML6346 |
| E = IRLML6402 | W = IRFML8244 |
| F = IRLML6401 | X = IRLML2244 |
| G = IRLML2502 | Y = IRLML2246 |
| H = IRLML5203 | Z = IRFML9244 |
| I = IRLML0030 | |
| J = IRLML2030 | |
| K = IRLML0100 | |
| L = IRLML0060 | |
| M = IRLML0040 | |
| N = IRLML2060 | |
| P = IRLML9301 | |
| R = IRLML9303 | |

Note: A line above the work week (as shown here) indicates Lead-Free.

W = (1-26) IF PRECEDED BY LAST DIGIT OF CALENDAR YEAR

YEAR	Y	WORK WEEK	W
2011	2001	1 01	A
2012	2002	2 02	B
2013	2003	3 03	C
2014	2004	4 04	D
2015	2005	5	
2016	2006	6	
2017	2007	7	
2018	2008	8	
2019	2009	9	
2020	2010	0 24	X
		25	Y
		26	Z

W = (27-52) IF PRECEDED BY A LETTER

YEAR	Y	WORK WEEK	W
2011	2001	A 27	A
2012	2002	B 28	B
2013	2003	C 29	C
2014	2004	D 30	D
2015	2005	E	
2016	2006	F	
2017	2007	G	
2018	2008	H	
2019	2009	J	
2020	2010	K 50	X
		51	Y
		52	Z

Note: For the most current drawing please refer to IR website at <http://www.irf.com/package/>



Micro3™ Tape & Reel Information

Dimensions are shown in millimeters (inches)

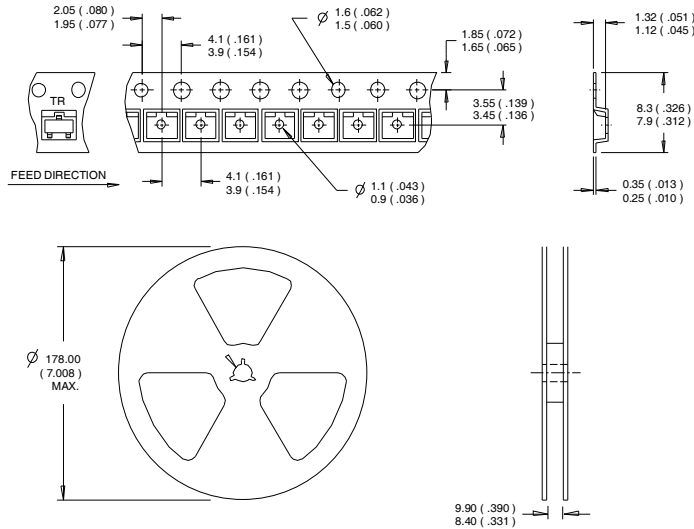

NOTES:
 1. CONTROLLING DIMENSION : MILLIMETER.
 2. OUTLINE CONFORMS TO EIA-481 & EIA-541.

Note: For the most current drawing please refer to IR website at <http://www.irf.com/package>

Qualification information†

Qualification level	Industrial (per JEDEC JESD47F†† guidelines)	
Moisture Sensitivity Level	Micro3™ (SOT-23)	M5L1 (per JEDEC J-STD-020D††)
RoHS compliant	Yes	

† Qualification standards can be found at International Rectifier's web site: <http://www.irf.com/product-info/reliability>

†† Applicable version of JEDEC standard at the time of product release

Revision History

Date	Comment
10/28/2014	• Updated partmarking to reflect Industrial partmarking on page 8.

International
 Rectifier

IR WORLD HEADQUARTERS: 101 N. Sepulveda Blvd., El Segundo, California 90245, USA
 To contact International Rectifier, please visit <http://www.irf.com/whoto-call/>